

一、SPECIFICATIONS :

- 1、Rated Voltage: 0.66KV
- 2、Insulation Voltage: 2KV
- 3、Rated Frequency: 50HZ or 60HZ
- 4、Operating Temperature: -15°C to 60°C
- 5、Flame resistance: UL94-V0
- 6、Certificates: CE、UL、ETL

二、FEATURES:

- 1、Small cost
- 2、Split core design ,Easier installation
- 3、Build diode ,no high voltage danger
- 4、Good linearity at very low current

三、DIMENSIONS(mm):

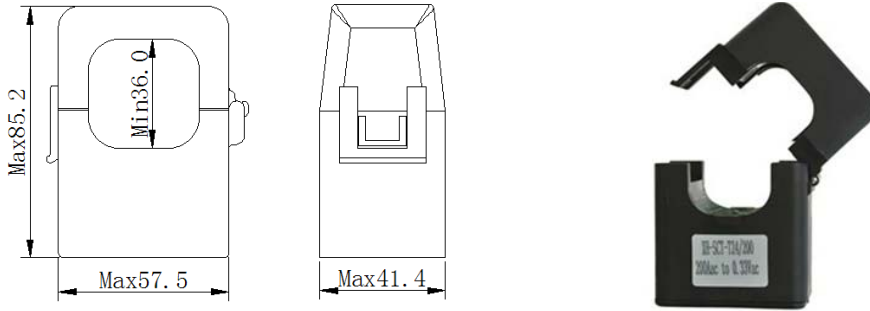

四、DIMENSIONS(mm):

Model	Input (A)	Max current (A)	Turns (T)	Burden (Ω)	Output
SCT0036-300/100mA	10A-300A	500	3000	100	mA/0.333VAC/0-5VAC

五、CURVE PERFORMANCE:

